



THE MOBILE & FLEXIBLY USABLE AIRCLEANER

FOR KITCHEN & LIVING AREA,
MEDICINE, HOTEL & GASTRONOMY

OZONOS®

TABLE OF CONTENTS

FINALLY FRESH AIR	03
THE OZONOS PRODUCT WORLD	04
COOKING AND LIVING? ONLY WITH OZONOS	06
WHY OZONOS AND HOW DOES IT WORK?	07
OZONE ONLY DOES ITS JOB AND DISAPPEARS.	08
WHERE CAN OZONE BE FOUND?	09
THE CEILING LAMP “STELLA”	10
THE FLOOR LAMP “HAILEY”	12
OZONOS ELIMINATES CORONA VIRUSES	14
THE OZONOS TRIPOD	16
THE ZONOS KITCHEN MODULE	18
OZONOS IN BUSINESSES	19
FIELDS OF APPLICATION	20
WHICH OZONOS SUITS US	28
DISINFECTION THROUGH CONTROLLED OZONE OUTPUT	30
TÜV CERTIFICATE	31
OZONOS TECHNICAL DATA SPECIFICATIONS & FEATURES	33
OZONOS USER EXPERIENCES	34



THE FACES BEHIND OZONOS

WELCOME TO THE WORLD OF OZONOS, THE MOBILE FRESH AIR WONDER!

We have found it - the solution for clean and clean air at home and at work. The mobile Aircleaner eliminates aerosol fats, bacteria, viruses, germs, mold spores, pet and mite allergens, pollen, pet and color odours in your home or workplace – with an innovative, patented method that uses the natural benefits of ozone. No chemicals, no filters. Eco-friendly, sustainable and inspired by nature.

Take a deep breath and discover the variety of our innovative products.

Have fun!

OZONOS Shareholders Thomas Brunauer, Niko Kovac, Roland Trettl and Fredy Scheucher.

THE OZONOS PRODUCT WORLD

MANY WAYS LEAD... to fresh and clean air!

OZONOS offers a broad range of products, so that everyone can find one that meets their individual needs!

Be curious, because we constantly extend our assortment!



OZONOS AC-I SERIE



FLOOR LAMP "HAILEY"



OZONOS KITCHEN MO



DULE



CEILING LAMP "STELLA"



OZONOS TRIPOD



COOKING AND LIVING? ONLY WITH OZONOS!

FROM FAN TO SHAREHOLDER - THAT'S WHY ROLAND
TRETTL HAS BECOME PART OF THE OZONOS TEAM...

»Becoming a partner of a company always means being convinced of a product. First it was the beauty of the product and then realizing that I can really say goodbye to my extractor hood. The aircleaner beautiful and quiet and I don't have to change a filter anymore.«

ROLAND TRETTL

CELEBRITY CHEF AND OZONOS SHAREHOLDER

Known from "First-Dates - Ein Tisch für zwei" and "Kitchen Impossible", (VOX) and for his work in the Red Bull Hangar-7 Restaurant "Ikarus"



WHY OZONE & HOW DOES IT WORK?

Ozone, also known as active oxygen, is a naturally occurring substance and consists of three oxygen atoms (O_3). It therefore has one oxygen atom more than the vital oxygen in our breathing air (O_2). This third oxygen atom makes ozone a highly reactive substance. It tries to form a bond with other substances or disintegrates into O_2 again. We make use of this attribute to neutralize smells, bacteria, viruses, germs, pollen, etc. Especially proteins and fats are those substances which react quickly with ozone and decompose. If ozone does not find a substance with which it can react, it decomposes into O_2 (oxygen) automatically after a short time. These are exactly the properties we need.

In everyday life we know ozone mainly from the ozone layer which protects us and as an air pollutant close to the ground. As a pollutant, ozone is mainly formed from emissions and solar radiation (summer smog). Ozone is therefore only ONE component of a pollutant cocktail. Its harmfulness lies particularly in the excessively high concentrations and other harmful additives. A clear distinction must be made from summer smog: First, for its function the OZONOS Aircleaner only produces ozone in low concentrations and no harmful pollutants. Secondly, even under unfavourable conditions, the ozone concentrations remain in continuous operation in a safe range of less than 0.05 ppm, e.g. with the OZONOS AC-I version (TÜV certification, testing of each individual UV-C lamp).

EU Directive 92/72/EEC (thresholds)

According to the EU directive, ozone does not pose a health risk at a concentration of 0.06 ppm. Information threshold / alarm threshold at 0.12 ppm. More information at EU Directives www.eur-lex.europa.eu or Bavarian State Office for the Environment www.lfu.bayern.de



OZONE ONLY DOES ITS JOB AND **DISAPPEARS.**

OZONOS TECHNIQUE

INSPIRED BY NATURE

For the production of ozone we copy the natural formation of it in the ozone layer.

In combination with oxygen (O_2), the UV-C light of the sun produces ozone (O_3).

The OZONOS Aircleaner uses exactly this principle: The UV-C bulb in the OZONOS Aircleaner takes on the role of the sun.

Contrary to the usual methods and environmental processes, no harmful nitrogen oxides are produced.

- No odour
- No bacteria
- No viruses
- No germs
- Only pure oxygen



OZONE GENERATORS

SO FAR: TOO MUCH OZONE, TOO LOUD AND TOXIC NITROGEN OXIDES



Not appropriate for use in occupied rooms.

Until now, ozone for domestic use has been generated by so-called ozone generators. These devices use very high voltages to generate ozone and/or ionized air by means of electrical discharges (corona discharges). On the market they are also called ionizers. The disadvantage: corona discharges produce toxic nitrogen oxides (NOX) in the air - the main pollutant of summer smog and absolutely undesirable in room air.

In addition, the amount of ozone produced, usually more than 1,000 mg/h, is much higher than, for example, 2.5 mg/h for OZONOS (model OZONOS AC-1).

The use of conventional ozone generators for odour neutralisation and disinfection of rooms is only possible in a very controlled way, for example if the room is not entered for several days, as in the case of a crime scene cleaning. In addition, the noise level is often indicated with more than 45 db (audibly loud, concentration disturbance).



WHERE CAN OZONE BE FOUND?

IN THE LAST FEW YEARS THERE HAS BEEN AN ENOURMOUS CHANGE IN THE SUBJECT OF OZONE.

In medicine, the use of ozone has been common for some time, for example in dentistry or for blood treatments.

The table below shows where ozone can be found in our daily lives and how it can be used. It can be clearly seen that our OZONOS AC-I is very far below the threshold values and specifications of the EU and the legislator.

Ozone is the most important gas in our environment and keeps nature in balance. We make use of this principle in our OZONOS products.

TYPICAL OZONE-CONCENTRATION IN PPM (PARTS PER MILLION)

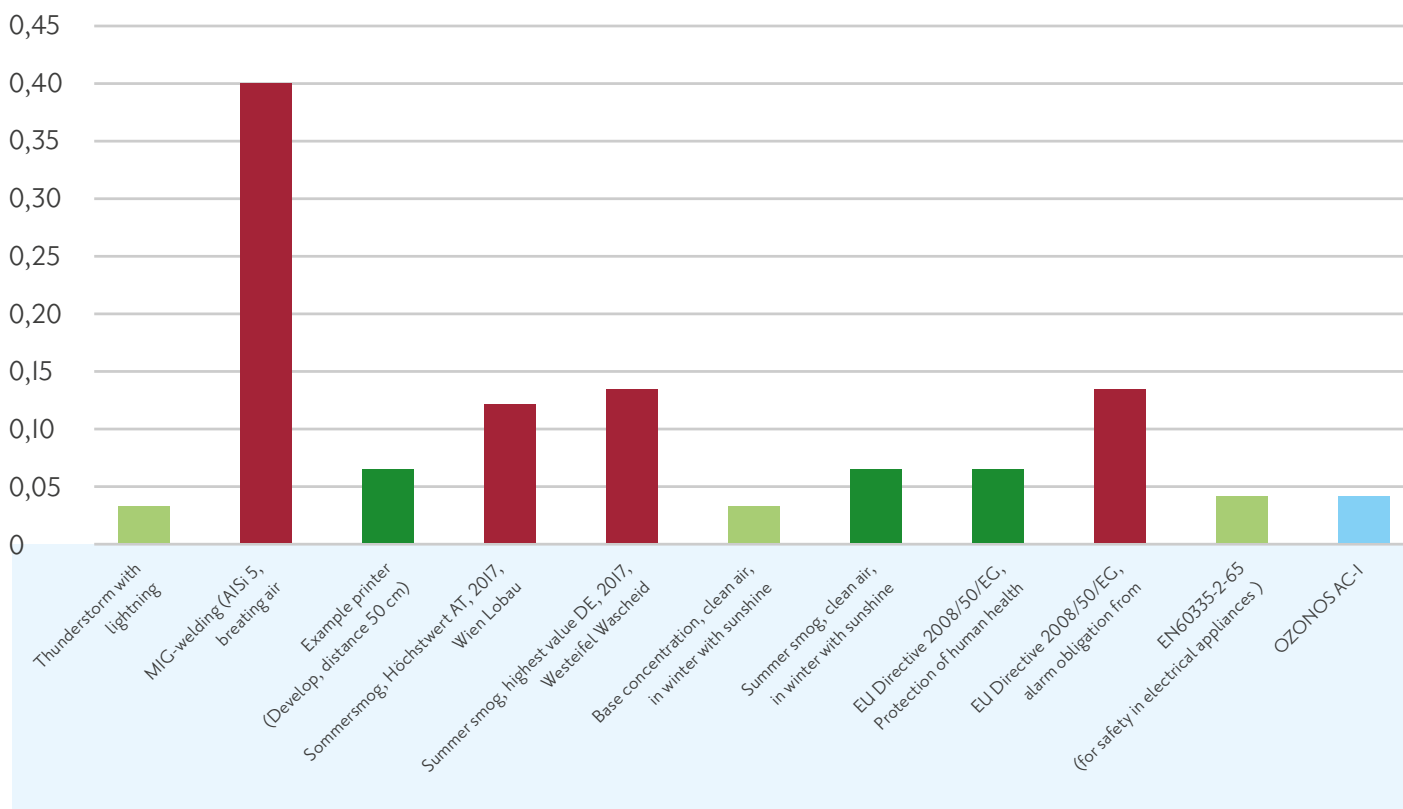



NEW

THE OZONOS CEILING LAMP “STELLA”

Everyone knows the annoying odours and aerosol fats in their kitchen, but nobody likes to place unsightly extractor hoods into their carefully planned kitchen.

OZONOS has the ideal solution!

Our new ceiling light “Stella” convinces not only with stylish design, but also with inner qualities: an integrated OZONOS AC-I PLUS! It brings light into the kitchen and at the same time eliminates unwanted odours and aerosol fats. Of course, the Aircleaner and the lamp can also be controlled separately.

Anthracite



White



DESCRIPTION CEILING LAMP "STELLA":

LENGTH:	1060 mm
WIDTH:	550 mm
HEIGHT:	220 mm
WEIGHT:	16,5 kg
LED-Strip 80W 24V 5700lm 2700K CRI>=90	
Driver & OZONOS AC-I PLUS integrated incl. remote control, surface metal case in white (RAL9016) or anthracite (RAL7016), surface glass A-WS acrylic white satined	
Connectivity: DALI, DSI, switchDIM, corridorFUNCTION, Casambi	



Anthracite RAL7016



White RAL9016



Jeans Grey



NEW LIFE QUALITY WITH “HAILEY” – THE FLOOR LAMP

FUNCTION MEETS MODERN DESIGN

The floor lamp “Hailey” combines the best of the areas of design and hygiene. Behind the high-quality and modern look hides an OZONOS AC-I or AC-I PLUS under a beautiful lampshade. Experience fresh air in a different way.

INNOVATIVE AND STYLISH

The light and the OZONOS AC-I can be controlled separately, as well as simultaneously. The OZONOS AC-I silently and secretly purifies the air and sustainably improves your quality of life. Winner of the Red Dot Award for outstanding product design.



DESCRIPTION FLOOR LAMP "HAILEY":

DIAMETER:	Ø600 mm
HEIGHT:	1740 mm
WEIGHT:	19 kg
LED:	24V/230V
54W, 4950lm, 2700K, CRI 90	
Driver & OZONOS AC-I integrated incl. remote control, Euro plug, footswitch, leg RAL 9005 fine structure black, acrylic white satined	

Jeans Grey



Linen Nature



Athene Creme



OZONOS ELIMINATES CORONAVIRUSES!

>99% IN THE AIR*

>92% ON SURFACES**

The accredited and internationally recognized test laboratory for hygiene and medical devices HygCen Germany GmbH has examined our products and confirmed: The OZONOS AC-I models effectively eliminate coronaviruses.

The complex test procedure proves that the OZONOS is effective against coronaviruses and significantly reduces the risk of infection indoors.

REDUCED RISK OF INFECTION AND NEW SAFETY FOR

- Medical practices
- Hotels & restaurants
- Kindergartens & schools
- Retirement & nursing homes
- Event venues
- Public institutions
- Sales rooms & offices



* proven by OFI Technology & Innovation GmbH

** tested according to EN17272 - HygCen Germany GmbH Accredited Test Laboratory





NEARLY UNLIMITED APPLICATION
WITH THE **OZONOS TRIPOD**



PLACEMENT

The best results are achieved from a height of 2m

OZONOS STATIV

(COMPATIBLE WITH THE OZONOS AC-I LINE)

- Easy adjustment and transport
- Ideal air circulation due to higher placement of the device
- Individual and easy height adjustment due to leg clamps and 3 air-damped extracts
- Including wheels. E.g. for use in hotel rooms.

DESCRIPTION OZONOS STATIV:

DIAMETER:	33-29-25 mm
HEIGHT:	maximum 300 cm
NET WEIGHT:	1,6 kg
LOAD:	9 kg



KITCHEN
MODULE FOR
THE OZONOS
AIRCLEANER

SUITABLE FOR
CABINETS WITH
60CM, 90CM
OR 120CM

INDIVIDUALLY
ADAPTABLE TO
YOUR KITCHEN

NEW

THE OZONOS KITCHEN MODULE

For all those who don't want to be without their OZONOS Aircleaner anymore - we have good news!

The AC-I line can now be integrated into every planned and already existing kitchen due to our new individually adaptable kitchen module!

The new kitchen module is available exclusively at our kitchen partners, such as HAKA Küche or Sachsenküchen. For detailed information, please contact your favourite kitchen manufacturer!



EXAMPLE CABINET INCL. KITCHEN MODULE

DOCTORS PRACTICES: WAITING ROOMS NO LONGER HAVE TO BE GERM-MAGNETS.

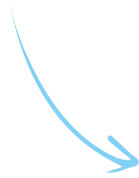

OZONOS IN BUSINESSES

HOTEL ROOMS

Fewer pathogens even at high room occupancy



TOILETS

Elimination of germs, bacteria and also odours



CONFERENCE ROOMS

Even with full occupation clean air and lower risk of contagion



OFFICES

Reduction of bacteria, viruses and germs in the workplace





APPLICATION IN KINDERGARTENS & SCHOOLS

EXAMPLES FOR APPLICATION:

- Reduction of germs and odours in toilets
- Odour-free changing rooms
- Reduction of bacteria and viruses in classrooms
- Better Hygiene in gyms, libraries and canteens



Also eliminates odours in clothing. Designed also for use in wardrobes or small rooms.

CLEAN AIR IN THE AREA FITNESS & SPORTS

EXAMPLES FOR APPLICATION:

- Hygienic changing rooms
- Viruses and germ-free training and treatment rooms
- Elimination of unpleasant odours
- Relief for allergy sufferers

» Not only for athletes, optimal conditions are important to achieve maximum performance. Everyone needs to live healthy and have fresh air - with OZONOS this is now possible. «

Niko Kovac

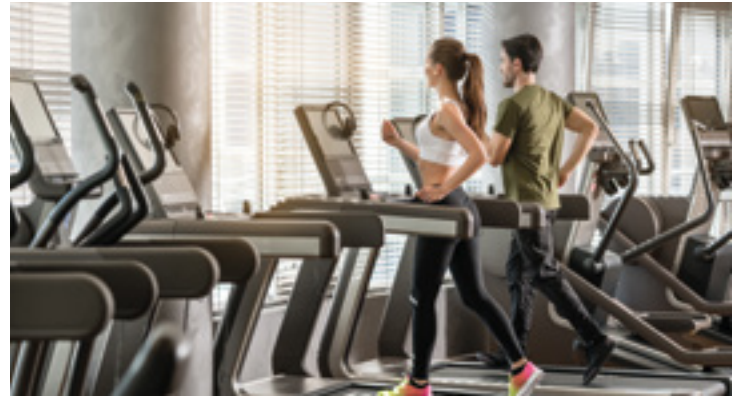

OZONOS IN THE CARAVAN

FRESH AIR - ALWAYS AND EVERYWHERE!

Everyone knows the annoying fumes and aerosol greases that arise during cooking and remain in the air and furniture long after eating. But also animal smells cause many caravan owners problems.

Especially in smaller spaces, one wants to counteract this quickly and effectively. OZONOS is a problem solver here! The Aircleaner completely and silently removes the unwanted odours and aerosol greases in the caravan.



NEARLY UNLIMITED APPLICATION IN HOTELS & GASTRONOMY

EXAMPLES FOR APPLICATION:

- Guest, common and meeting rooms
- Skiboot and drying rooms
- Kitchen area
- Fitness area
- Spa-Area, Changing rooms & Solariums
- Smoking areas
- Hotel rooms

AND MANY MORE ...



»I am very sensitive to bad odours, and eliminating them with OZONOS is ideal. In addition, the Aircleaner is a weapon against germs and viruses - for the health of employees and guests.«

Roland Trettl









NEARLY UNLIMITED APPLICATION IN THE MEDICAL SECTOR

EXAMPLES FOR APPLICATION:

- Pharmacies
- Hospital rooms
- Doctors practices
- Waiting rooms / receptions
- Hospital Laundry Rooms
- Vet Practices
- Physiotherapy Rooms

AND MANY MORE ...



DOCTORS
PRACTICES &
WAITING ROOMS
NO LONGER HAVE
TO BE GERM
MAGNETS



OZONOS FOR ALLERGY SUFFERERS

MORE HYGIENE
IN GERM
BURDENED
ROOMS



The mobile Aircleaner OZONOS is especially suitable for allergy sufferers. No matter if pollen allergens, animal hair or house dust - if the air is polluted by allergy-causing components, this is a horror for allergy sufferers during the day and at night. OZONOS cleans the air and additionally ensures hygiene in germ-contaminated living rooms and bedrooms.

OZONOS requires neither chemicals nor filters and, thanks to its extremely low energy consumption, can be used around the clock.

ENVIRONMENTALLY FRIENDLY, SUSTAINABLE AND ABOVE ALL HARMLESS TO HEALTH

Disinfection with ozone is considered one of the most environmentally friendly methods of achieving sustainable elimination of unpleasant odours and harmful microorganisms. No filters or chemicals are required.

MORE EXAMPLES: Shoe rooms, wardrobes, caravans and yachts in winter storage.

IMPROVED CLIMATE TO LIVE AND WORK

Numerous tests and studies prove that the use of the OZONOS Aircleaner is harmless for you and your four-legged friends: When used correctly, the limit values are adhered to and there is no UV-C exposure outside the device.

The ozone is generated by the device and, due to its responsiveness, immediately reacts with germs, spores, odours, etc.

If nothing is left, the ozone quickly decomposes to normal oxygen due to its short half-life.,

In the sleeping area, the proteins of the skin cells or pollen are removed. As a result, mites lose their food and die, leading to a significant improvement in air quality for allergy sufferers.

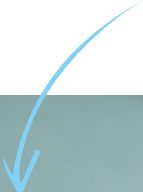

ABSOLUTELY
HARMLESS FOR
HUMANS AND
ANIMALS

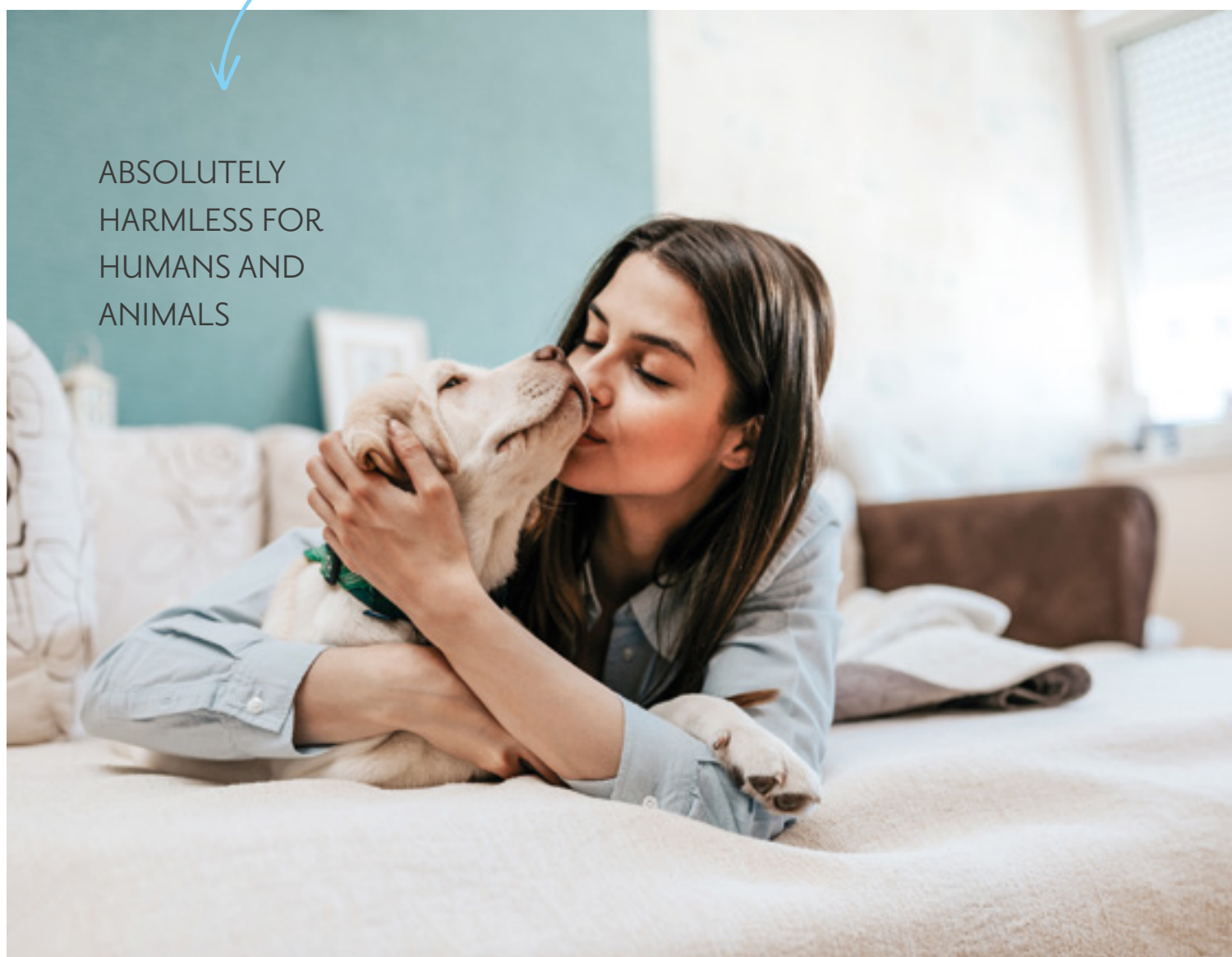

WITHOUT OZONOS

Harmful emissions



Bacteria & Mould spores



Fumes & Odours



Viruses & Allergens



Skin cells

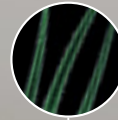

WHICH OZONOS SUITS US?

All three versions are available in all three colours



OZONOS AC-I



OZONOS AC-I PLUS*



OZONOS AC-I PRO*

**WE CREATE A BETTER CLIMATE
TO LIVE AND WORK**

WITH OZONOS



The OZONOS AC-I

is designed for permanent use and therefore allows you to be in the same room 24/7. Particularly suitable for smaller rooms such as cold storage rooms or hotel rooms.

Elimination of normal odour disturbance or low levels of bacteria, viruses or germs. Perfect for creating allergy-friendly rooms.

The OZONOS AC-I PLUS*

is designed for quick and intensive cleaning. It is particularly suitable for heavy and strong odours or a high bacterial, viral or germ load.

Used e.g. in ski shoe rooms, larger rooms, kitchens or cooling rooms, etc.

The OZONOS AC-I PRO*

aims very strongly at the professional user or also for the private area. In areas where it is important to achieve a convincing result within the shortest time.

Areas of application: Garbage rooms, ski shoe rooms, heavily odour-contaminated and germinated areas.

*The OZONOS AC-I PLUS and AC-I PRO are not designed for 24/7 use where people stay in the same room permanently. We recommend not to stay in the room for longer than 8 hours when operating the device. OZONOS AC-I PLUS and AC-I PRO are particularly suitable for professional use and for quicker and more intensive cleaning.

DISINFECTION THROUGH CONTROLLED OZONE OUTPUT

OZONOS in detail: The integrated fan draws polluted air into the interior of the OZONOS. The specially developed UV-C bulb generates ozone from the oxygen in the air. The highly reactive ozone immediately reacts with odour molecules, proteins and fats. Odours, spores, germs etc. are thereby eliminated. The cleaned air is then returned to the room.

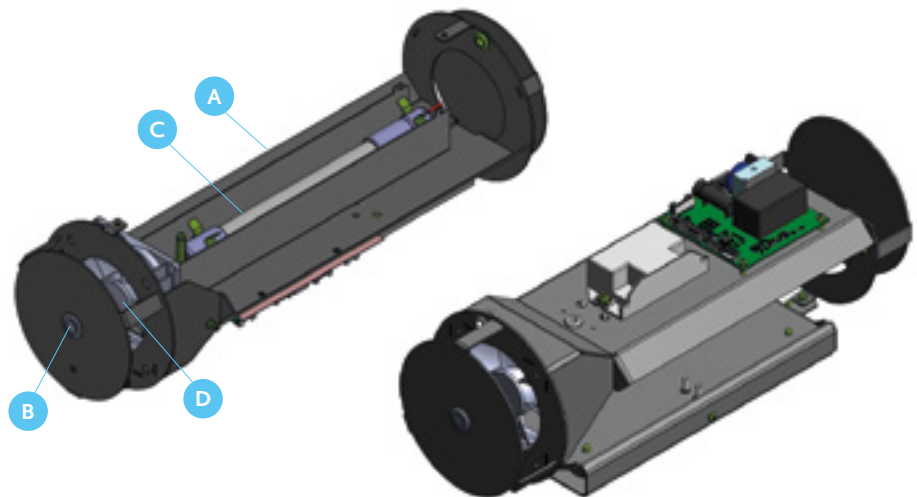
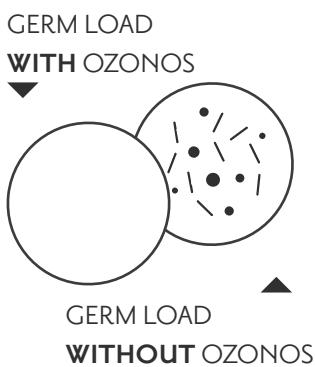

A Case · B On/Off button with blue control light · C UV-C special bulb · D Fan

EVERYTHING FOR YOUR SAFETY

TÜV CERTIFIED AND CONVINCING IN NUMEROUS TESTS

The OZONOS AC-I produced according to ISO 9001:2015 was successfully tested in the laboratory by TÜV SÜD Product Service for compliance with legal standards (EN60335-2-65, maximum 0.05 ppm ozone concentration) and certified by Quality Austria Trainings, Zertifizierungs und Begutachtung GmbH. In addition, long-term and stress tests as well as the CE Declaration of Conformity prove the safety, electromagnetic compatibility and interference immunity.

The OZONOS AC-I is therefore not only effective in practice, but also tested by independent tests and therefore harmless to health.

 Produced according to DIN 9001:2015

 **MADE IN AUSTRIA**

TÜV CERTIFICATE

TEST REPORT OF
MARCH 20, 2017
No. 24493-01305-01
(Edition I)

TEST BASIS
EN 61000-6-3:2007 + A1:2011
+ AC:2012
EN 61000-6-2:2014
EN 61000-6-3:2013
EN 61000-6-6:2007

TEST RESULTS

FULFILLED

The tests were successfully passed.

TEST FOR INTERFERENCE IMMUNITY

- ✓ radiated disturbances
- ✓ harmonics
- ✓ voltage fluctuations
- ✓ interference voltage
- ✓ electromagnetic HF fields
- ✓ static electricity discharge
- ✓ asymmetric high frequencies
- ✓ fast transients
- ✓ surge voltages
- ✓ voltage dips and interruptions

*Our OZONOS AC-I model has been certified and approved by the TÜV SÜD via our manufacturer "Digital Elektronik GmbH".
We are currently in the process of subcertification and because of legal purposes are not allowed to use the TÜV SÜD logo until further notice.



MEASURING
In the testing room



MEASURING
voltage fluctuations



MEASURING
Electromagnetic HF fields

QUALITY MADE IN AUSTRIA

TEST REPORT OF 22 JUNE 2016

Registration No.: 01511/0

TEST BASIS

Quality Management System

Standard: ISO 9001:2015

CERTIFICATION ISSUE

Quality Austria -Trainings, Zertifizierungs und Begutachtungs GmbH issues a **qualityaustria** certificate to our manufacturers:



Digital Elektronik Ges.m.b.H

A-5083 St. Leonhard bei Salzburg,
Berchtesgadner Straße 10

A-5580 Tamsweg
Johann-Kopfmüllerstraße 6



Digital Elektronik d.o.o.

Ul. Kninska bb
BH-74400 Derвента

TEST RESULTS



FULFILLED

Confirmation of the application and further development of an effective quality management system.



OZONOS TECHNICAL DATA

SPECIFICATIONS & FEATURES

	OZONE CONCENTRATION					
UV-C COATING	10%	0,048 ppm	25%	0,115 ppm	50%	0,210 ppm
	OZONOS AC-I		OZONOS AC-I PLUS*		OZONOS AC-I PRO*	
MEASUREMENTS	L 400 mm · Diameter 130 mm · Weight 3,2 kg					
UV-C BULB	1 x 8 watt		1 x 8 watt		1 x 8 watt	
INPUT POWER	14 watt		14 watt		14 watt	
UV-C BULB	Durability of the UV-C bulb: 8.000 operating hours					
AIR FLOW RATE p.h.	ca. 55 m ³ ca. 25 m ²		ca. 55 m ³ ca. 25 m ²		ca. 55 m ³ ca. 25 m ²	
VOLUME	37 db		37 db		37 db	
REMOTE CONTROL	yes		yes		yes	
COLOURS	<p style="text-align: center;">Every version is available in all colours!</p> <div style="display: flex; justify-content: space-around; align-items: center;"> <div style="text-align: center;">  black – powder-coated </div> <div style="text-align: center;">  silver – powder-coated </div> <div style="text-align: center;">  white – powder-coated </div> </div>					

*The OZONOS AC-I PLUS and AC-I PRO are not designed for 24/7 use where people stay in the same room permanently. We recommend not to stay in the room for longer than 8 hours when operating the device. OZONOS AC-I PLUS and AC-I PRO are particularly suitable for professional use and for quicker and more intensive cleaning.

THIS IS WHAT OZONOS USERS SAY

Be inspired by the experiences of our customers.

»The OZONOS devices are used in several versions in various rooms and areas of the restaurant “Meyers Keller”. We are very satisfied with the performance of the devices. With their modern design and easy handling, they are perfect for our needs. We will buy even more OZONOS Aircleaners!«



Jockl Kaiser
Star Chef & Manager of Restaurant
Meyers Keller
www.jockl-kaiser.de

»What an awesome OZONOS! For now on the only stinky thing is me sometimes. Fresh air in the kitchen thanks to OZONOS!«



Tim Raue
Star Chef & Manager of Restaurant Tim Raue
www.tim-raue.at

»In the Smile Clinic Salzburg we use the OZONOS® system for disinfection of the bacterial or viral contaminated aerosol cloud, which develops during the dental treatment. In this way we actively protect our employees from illnesses.«



Dr. med. univ. et med. dent
Sehdi Sarmini
Economic Clinic Management
www.smile.at

»The air quality in my practice has improved considerably through the use of OZONOS. This is especially noticeable in the waiting room. Even with a high number of patients the room climate does not suffer and the reduced germ load is an additional benefit for staff and patients.«



Dr.
Susanne Obermann
Salzburg

»We are very pleased that the OZONOS technology enables us to give our customers, passengers and employees not only safety, but also a further level of trust in travel and health.«



Paul and Thomas Blaguss
BLAGUSS Group
www.blaguss.at

»For our Alm Resort we bought the OZONOS Aircleaner. Germ and bacteria free rooms are the absolute added value for us. We will buy more OZONOS AC-I to be able to offer our guests rooms for allergy sufferers in the future.«



Mario Eichelhardt
Alm Resort Nassfeld
www.almresort-nassfeld.com

»The devices are used in the VIP area and offer our guests additional safety during the matches. The fact that bacteria, germs and viruses in the air are eliminated by OZONOS is an enormous added value in areas where many people gather.«



Johannes Prem
EC Red Bull Salzburg
www.ecrbs.redbulls.com

»We use the OZONOS® Aircleaner in our treatment and waiting rooms to protect our patients from germs and bacteria even better. In addition to this increased protection, it is also a great side effect that odours are eliminated across all areas.«



Dr. med.
Katharina Reschen
Practice Management
www.ord-reschen.com

» On set but also e.B. in common areas we have cleaned the air with OZONOS devices. The OZONOS devices eliminate 100% of viruses and bacteria in the air and over 90% on surfaces. Our experience has been consistently positive..«



Tresor TV
www.tresor.tv

»The device not only met my expectations, but even exceeded them. A must for any responsible doctor in waiting rooms and in the surgical area. Smells during cooking and pollen allergies are also reduced positively. Even the design is very appealing.«



DDr.
Helmut Falch
Doctor of dental, oral and maxillofacial medicine

»We have recently started using the OZONOS Aircleaner in the Krabbelstube Kuschelkiste. The air quality (unpleasant odours) has noticeably improved, especially in the movement room and the sleeping room.«



Karin Schosser
Team Management Nursery "Kuschelkiste"
www.kuschelkiste.at

»Wir haben innovative Technologien eingeführt und Marriott Sauberkeitsprogramme umgesetzt. Neben den Personalausbildungen sind unsere hochwertigen OZONOS-Luftreiniger nicht nur gegen Viren von Vorteil, sondern bieten auch Menschen, die unter Allergien leiden, saubere Luft!«



Hotel Goldener Hirsch
Salzburg
www.goldenerhirsch.com

»I always had lots of problems with my allergy. After a long search I finally found something that really helps and that I can rely on: the OZONOS Aircleaner! Since I have it at my side, my allergy cannot harm me any more. I feel much more stable and healthy!«



European rowing champion
Magdalena Lobnig
2x bronze at world championships
www.magdalenalobnig.at

»In our two hotels Neutor and Neutor Express in Salzburg we have recently started using an OZONOS AC-I PRO device to eliminate unpleasant odours primarily in our rooms and to offer our guests a hygienic atmosphere in their rooms. We are already considering equipping other areas with OZONOS devices.«



Axel Teckentrup-Kurz
Director of Hotel Neutor Betriebs GmbH
www.neutor.com

THE FIRST OZONE DEVICE WITH
TÜV CERTIFICATION*
& CE-APPROVAL



HAKAKÜCHE

HÄFELE

SACHSEN
KÜCHEN

nolte
KÜCHEN

Media Markt

RED ZAC
Elektronik. Voller Service.

EP:
ElectronicsPartner

LOHBERGER

METRO

HOLTER

SERVICE & MORE
GEMEINSAM ERFOLGREICH

SECOMP

EK/servicegroup

hali

elastica
SCHLAFSYSTEME

Europa Möbel
Ergänze- & Möbelgruppen

euronics

GERL.
DENTAL



MZE
NETZWERK WOHNKÜCHE

SinfoMed

TFK
AUSTRIA

IKANZLSPERGER

YOUR CONTACT:

OZONOS GMBH

Ginzkeyplatz 11 · A-5020 Salzburg
M frischluft@ozonos.com · W www.ozonos.com

OZONOS SCHWEIZ GMBH

Kirchstrasse 5 · CH-8104 Weiningen
M frischluft@ozonos.ch · W www.ozonos.ch

OZONOS ASIA

Peter Murhammer
83/11 Moo 4, Koh Kaew Sub District, Muang-
Phuket District · Phuket Province 8300
M asia@ozonos.com · W www.ozonos.com